

**SPLIT TYPE**
**VIOLET**
**Model:  
KW30HQ2B4D**

Item	Unit	Specification
ODU Model	–	KW30HQ2B4DO
IDU Model	–	KW30HQ2B4DI
System Ratings		
Cooling Capacity	Btu/h	28,000
Heating Capacity (47°F)	Btu/h	28,400
Heating Capacity (17°F)	Btu/h	19,200
Cooling Capacity Range	Btu/h	9,485-30,026
Heating Capacity Range	Btu/h	9,997-32,994
Cooling Power Input (Max)	W	3,900
Heating Power Input (Max)	W	4,000
SEER	–	18.0
HSPF	–	9.0
EER	W/W	10.4
COP	W/W	3.0
Cooling Operation Range	°F (°C)	0~115.0 (–18.0~46.0)
Heating Operation Range	°F (°C)	–4~75.0 (–20.0~24.0)
Gas Pipe Size (OD)	Inch	5/8
Liquid Pipe Size (OD)	Inch	1/4
Connection Method	–	Flared
Factory Charge	oz	84.7
Additional Charge	oz/ft	0.54
Pre-Charge Length	ft.	25
MAX Refrigerant Length	ft.	98
Min Refrigerant Pipe Length	ft.	10
MAX Refrigerant Pipe Elevation	ft.	33
Indoor Unit Data		
Fan Motor Power Output	W	70
Fan Motor FLA	A	0.4
Air Flow Volume	CFM	412/706
Sound Pressure Level	dB(A)	37/51
Dehumidication	pt/hr	6.34
Power Supply	–	208/230V / 1Ph / 60Hz
Min/Max Voltage	V	187 - 253
MCA	A	20.0
MOCP/Breaker Size	A	30.0
Outdoor Unit Data		
Compressor Type	–	DC Inverter Rotary
Compressor RLA	A	13.5
Refrigerant Type	–	R410A
Fan Motor Power Output	W	120
Fan Motor FLA	A	0.45
Sound Pressure Level	dB(A)	62
Power Supply	–	208/230V / 1Ph / 60Hz
Min/Max Voltage	V	187 - 253
Main Supply Wire Size	–	10-2 AWG
MCA	A	20.0
MOCP/Breaker Size	A	30.0

**Job Name:**
**Schedule Reference:**
**Date:**



Outline and Physical Dimension of KW30HQ2B4D.

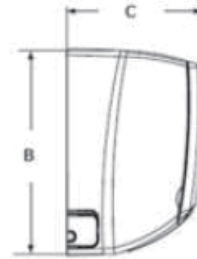
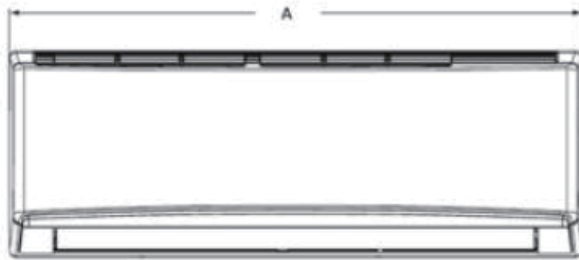

Dimensions	
A	53 1/8
B	12 3/4
C	10

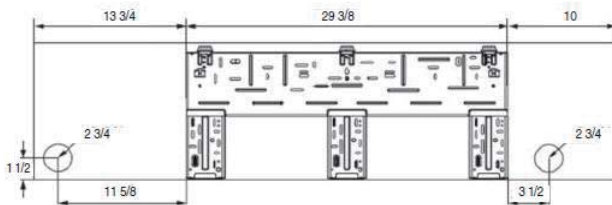

Liquid Line Valve	1/4-in OD Flared
Gas Line Valve	5/8-in OD Flared
Drain Connector	5/8-in OD

y

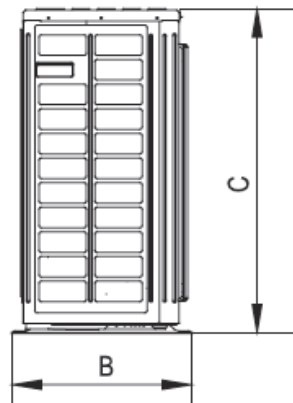
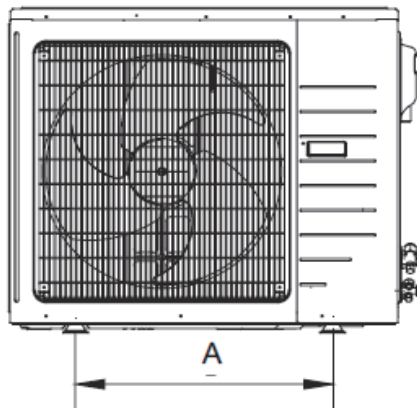

Dimensions	
A	24
B	16 3/4
C	31 1/8
D	38 5/8
E	14 1/2

y

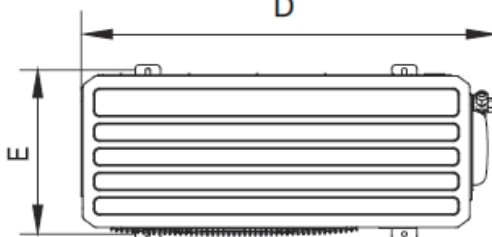

Liquid Line Valve	1/4-in OD Flared
Gas Line Valve	5/8-in OD Flared

Net Weight IDU	lb
Gross Weight IDU	lb
Net Weight ODU	lb
Gross Weight ODU	lb



### COOLING PERFORMANCE (BtuH)\*

Outdoor Ambient DB	Indoor Ambient Temperature							
	68F DB (20C)		73F DB (23C)		80F DB (27C)		82F DB (28C)	
	57F WB (14C)		61F WB (16C)		67F WB (19C)		68F WB (20C)	
	TC	SHC	TC	SHC	TC	SHC	TC	SHC
5°F	16,626	13,039	17,564	13,770	19,822	15,547	20,120	15,780
14°F	18,288	14,343	19,320	15,147	21,805	17,102	22,132	17,358
23°F	20,037	15,718	21,432	16,811	24,556	19,260	25,047	19,549
32°F	20,838	16,346	22,289	17,484	25,539	20,030	26,049	20,331
41°F	21,672	17,000	23,181	18,183	26,560	20,832	27,091	21,144
50°F	22,539	17,680	24,108	18,910	27,623	21,665	28,175	21,990
59°F	24,298	19,057	25,990	20,383	28,464	22,318	29,034	22,653
68°F	27,518	21,583	29,238	22,928	31,245	24,506	31,870	24,873
77°F	27,194	21,331	28,923	22,686	30,958	24,283	31,577	24,647
86°F	25,856	20,276	27,576	21,631	30,098	23,606	30,700	23,960
95°F	24,470	19,192	26,181	20,528	28,665	22,483	29,238	22,820
104°F	23,286	18,263	24,986	19,599	27,920	21,902	28,478	22,231
113°F	22,091	17,324	23,792	18,660	26,735	20,963	27,270	21,278

### HEATING PERFORMANCE (BtuH)\*

Outdoor Ambient DB	Indoor Ambient Temperature							
	68F DB (20C)		73F DB (23C)		80F DB (27C)		86F DB (30C)	
	57F WB (14C)		61F WB (16C)		67F WB (19C)		72F WB (22C)	
	TC	SHC	TC	SHC	TC	SHC	TC	SHC
-4°F	15,986	15,986	15,717	15,717	15,259	15,259	15,083	15,083
0°F	17,322	17,322	17,034	17,034	17,178	17,178	16,332	16,332
6°F	18,274	18,274	17,966	17,966	18,126	18,126	17,226	17,226
10°F	19,033	19,033	18,716	18,716	18,878	18,878	17,947	17,947
16°F	19,610	19,610	19,283	19,283	19,441	19,441	18,485	18,485
19°F	19,985	19,985	19,658	19,658	19,816	19,816	18,841	18,841
24°F	22,234	22,234	21,898	21,898	22,129	22,129	21,091	21,091
32°F	24,849	24,849	24,513	24,513	24,817	24,817	23,705	23,705
41°F	27,839	27,839	27,512	27,512	27,891	27,891	26,695	26,695
43°F	28,589	28,589	28,252	28,252	28,662	28,662	27,445	27,445
47°F	31,069	31,069	30,530	30,530	30,757	30,757	29,204	29,204
53°F	31,376	31,376	30,828	30,828	31,064	31,064	29,492	29,492
59°F	32,097	32,097	31,530	31,530	31,766	31,766	30,165	30,165
64°F	32,780	32,780	32,203	32,203	32,448	32,448	30,809	30,809
70°F	33,395	33,395	32,818	32,818	33,060	33,060	31,395	31,395
75°F	33,866	33,866	33,270	33,270	33,525	33,525	31,828	31,828

\* Maximum system capacity

TC- Total Capacity ( BtuH)

SHC- Sensible Capacity (BtuH)



**DIMENSIONAL SPECIFICATIONS**

**KW30HQ2B4D**

**MINIMUM SPACING REQUIREMENTS**

Units: inch (mm)

**INDOOR**

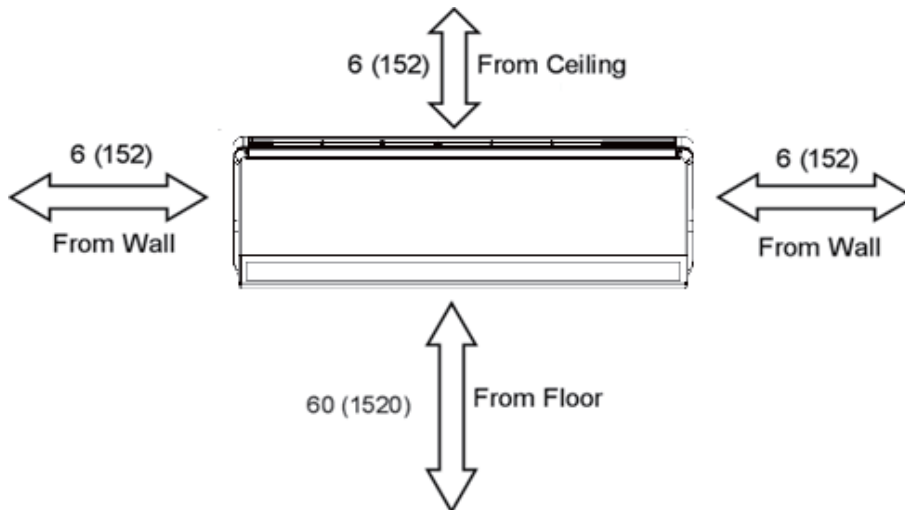

Units: inch (mm)

**OUTDOOR**

