

GMV

GMV-ND30A/B-T(U)



Specifications	Unit	Parameter
Model	—	GMV-ND30A/B-T(U)
Performance		
Rated cooling capacity	kBtu/h	30
Rated heating capacity	kBtu/h	34
Sound pressure level	dB(A)	40/42/44
Electric data		
Power supply	Voltage,Phase,Hertz	208/230,1,60
Maximum Overcurrent Protection(MOP)	A	15
Minimum Circuit Amps(MCA)	A	4
Fan		
Type×Qunity	—	Centrifugal×1
Air Flow Volume	CFM	710/820/910
ESP	Pa	50/0~250
Fan Motor Running Current	A	2.8
Fan Motor Power Output	W	370
Refrigerant Piping		
Connection Pipe	Gas(mm/inch)	Φ15.9, 5/8
	Liquid(mm/inch)	Φ9.52, 3/8
Connection Method	—	Brazing Connection
Refrigerant	—	R410A
Dimension/Weight		
Dimension(H×W×D)	mm/inch	1105×460×540
		43-1/2×18-1/2×21-1/4
Net Weight	kg/lbs	56/123
Other		
Safety Certification	—	ETL

Job Name:

Schedule Reference:

Date:

Specification are subject to change without notice.

Outline and Physical Dimensions of GMV-ND30A/B-T(U)

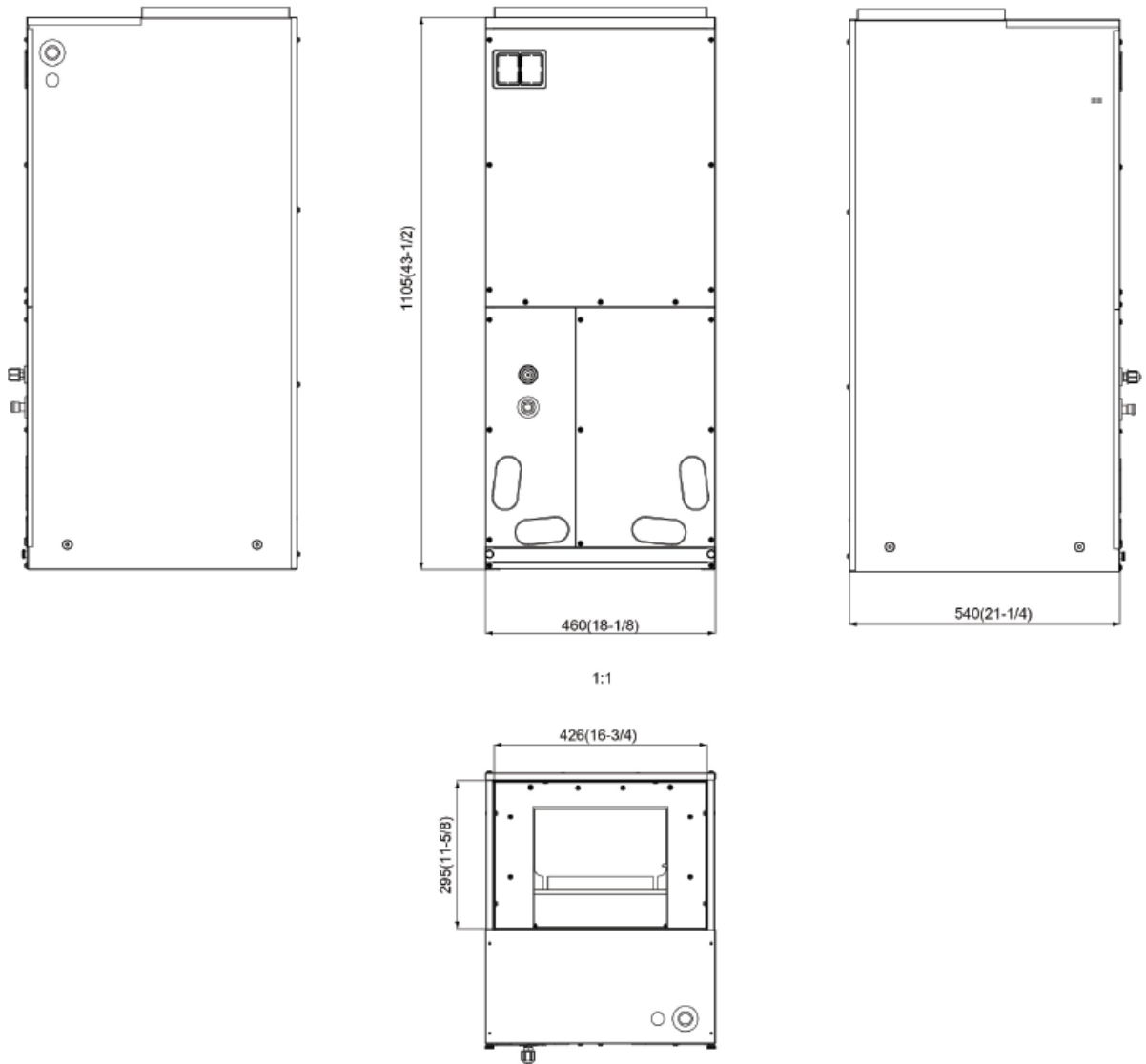

Unit: mm(in.)

Installation space

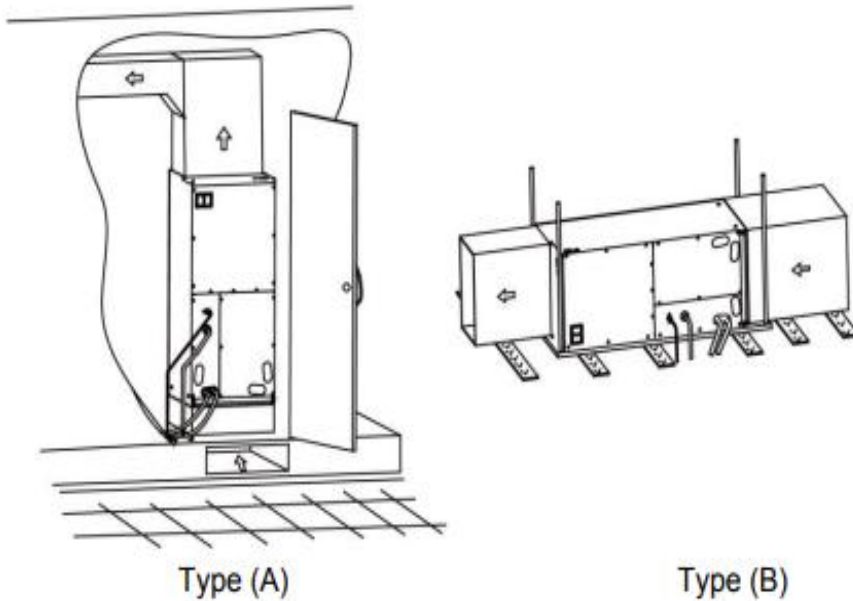

Type A: Vertical Installation
Type B: Horizontal Installation

