



# GREE

## PACKAGED WINDOW HEAT PUMP

---

**Cold Climate, Superior Comfort**  
**All-in-One Window Solution for Year-Round Comfort**

# Real Heat Pump Performance

Designed for extreme climates, Gree delivers reliable heating and cooling with cutting-edge technology



**109°F (43°C)**

9,300 BTU Cooling Capacity  
30% higher max cooling capacity  
for intense summers

**-15°F (-26°C)**

9,900 BTU Heating Capacity  
164% better low-temperature  
performance than standard units

## Guaranteed Comfort

**ENERGY STAR Certified | CEER 15.1 | HEER: 7.7**

56% improved heating efficiency and eco-friendly operation

**No Electrical Upgrades**

No dedicated circuit or wiring modifications needed

**No Plumbing Required**

Self-evaporative and optional drain hose minimize water handling

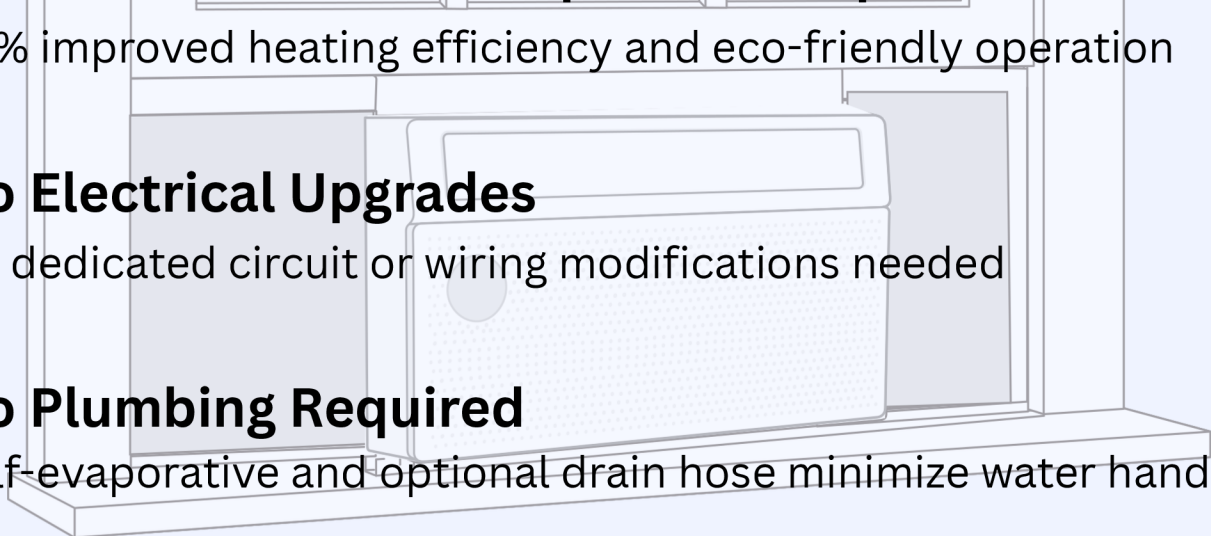

# Cutting-Edge Technologies

## All-DC Inverter System

Dual DC motors and CFD fluid simulation for peaceful comfort  
Adjusts compressor speed for energy savings

## Two-Stage Enthalpy-Adding Compressor

Ensures warmth even at -15°F

## Upgraded Touch Panel

Intuitive controls with eco mode and maintenance alerts

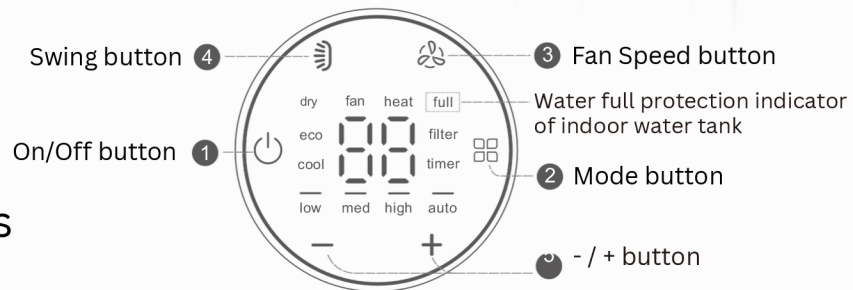

# Optimal Solution for Savings



## Save Energy and Money

Lower energy bills vs. traditional window AC units



## Save Complexity

No professionals needed to install

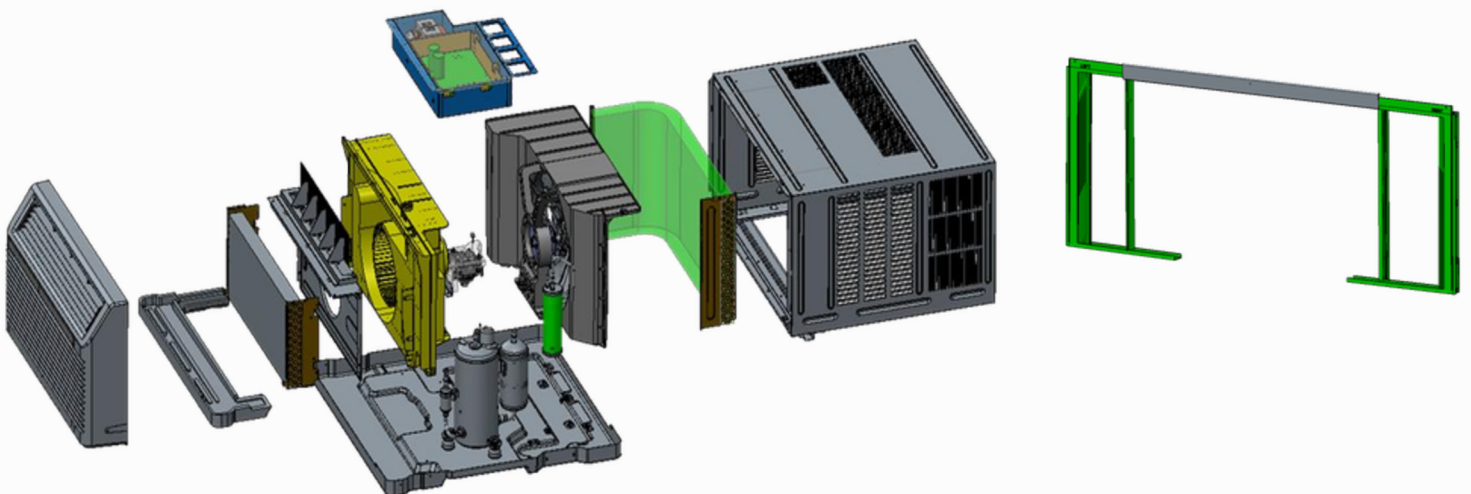

# Designed for Every Room

## Residential Spaces

- Houses
- Apartments
- Condos
- Sunrooms
- Garage
- Basement



## Commercial Spaces

- Hotel Rooms
- Offices
- Retail Shops
- Salons & Spas
- Classrooms
- Hospitals

# Always Perfect Climate

## Smart Controls

Mobile app control for comfort anywhere  
Filter-cleaning reminders

BACnet compatible for centralized commercial management

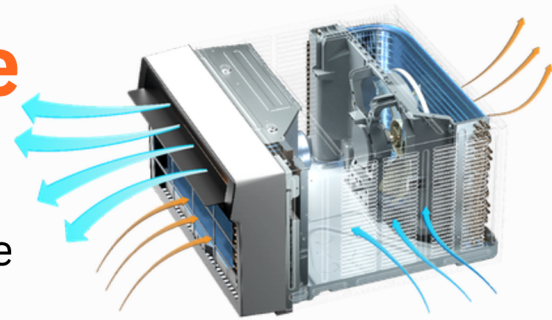

## Long Distance Airflow

Even cooling/heating for spaces up to 450 sq. ft

## R32 Refrigerant

Eco-friendly and high efficiency

## Advanced Water Tank System

Dual-tank design for efficient drainage  
Auto-evaporates moisture before collection  
"Full tank" alert for timely maintenance

## Ultra-Quiet Operation

43dB noise level for tranquility



# Power Meets Precision

Model	—	<b>GJH09BW-A6DRNL1A</b>
Cooling Capacity	Btu/h	9300
Heating Capacity	Btu/h	9900
Power Supply	—	115V/1Ph/60Hz
Sound Pressure Level(lowest)	dB(A)	43
CEER	—	15.1
HEER	—	7.7
COP(17F)	w/w	2.0
Cooling Power Input	W	830
Heating Power Input	W	900
Cooling Current Input	A	7.3
Heating Current Input	A	8
Minimum - Maximum Voltage	V	104-126v
External Dimensions ( W*H*D )	inch	26*15.3*27.5
Package Dimensions ( W*H*D )	inch	30.3*16.5*31
Net Weight	kg/lbs	52.5 / 115.8
Gross Weight	kg/lbs	59/130
Refrigerant Type	—	R32
Refrigerant Charge	oz	29.98
Temperature operation range for cooling	°F	64-109
Temperature operation range for heating	°F	-15-86
Air flow(H\M\L)	CFM	312/282/206
Fan motor	2	DC
Compressor	1	Inverter
Loading QTY(20'GP/40'GP/40'HQ)	pcs	105/225/267

## 1 Unit, 0 Hassles

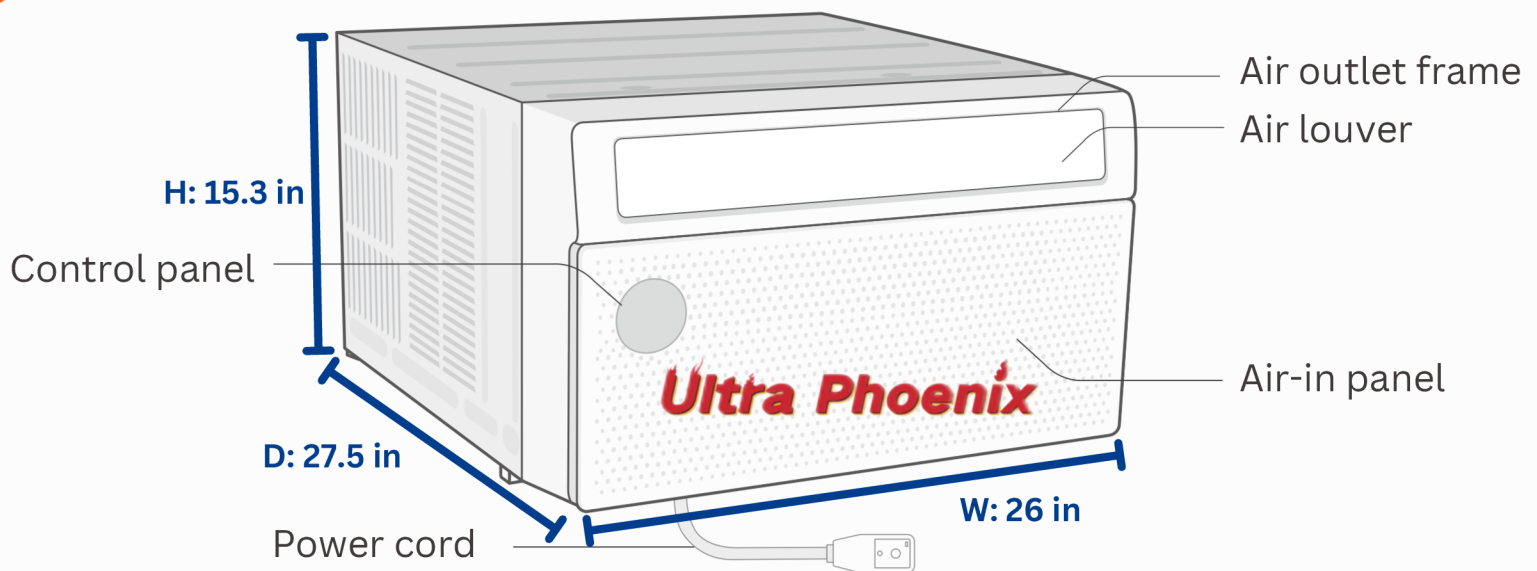

Top View

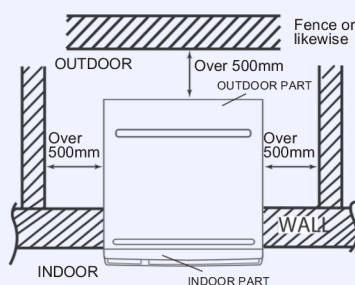

Front View

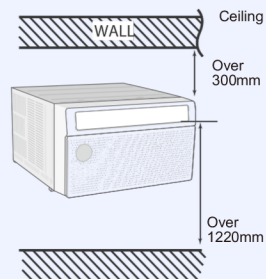



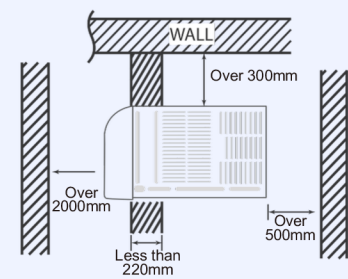





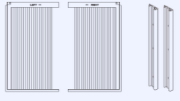







Side View

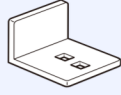



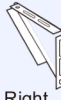

# Tailored Air, On Demand

## Accessory list

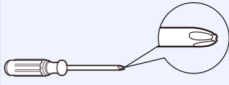
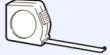
 Flexible screen and strip of flexible screen	 Sealing strip (without adhesive)	 Type F screw (2)	 Battery (AAA 1.5V)	
 Sealing strip (with adhesive)	 Upper guide rail	 User's manual	 Remote controller	
 Sealing strip (with adhesive)(2)	 Sponge	 Supporter (2)	 Type A screw (10)	 Type C screw (4)
 R1 Sealing sponge of flexible screen(2)	 Left tripod (1)	 Right tripod (1)	 Fixing bracket for window (2)	 Type E screw (4)

## Tools needed for installation

 Phillips screwdriver	 Measuring tape
 Straight screwdriver	 Scissors
 Level bar	 Pencil

## 1-2-3 Setup: Place, Secure, Enjoy

1

Simply slide the unit into your window—no heavy lifting! Its compact design fits most standard windows effortlessly.

2

Attach flexible screens, lock the brackets, and seal gaps with built-in sealing strips for a snug, energy-efficient fit.

3

Just plug into any standard outlet—no special wiring—and savor instant heating or cooling at the touch of a button!



## **Y & N Gree Commercial USA**

Phone: +1 786-536-7837

Email: [info@gree-america.com](mailto:info@gree-america.com)

Website: [www.gree-america.com](http://www.gree-america.com)

Address: 2520 West 78th St, Unit 5, Hialeah, FL 33016